

EVERHOT STOVE AND HEATER

Model	Power Rating (kW)	Power Cable Length (m)	Depth (mm)	Oven Size Width x Height x Depth (mm)	Approximate Max Oven Temperature (°C)	Weight (Kg)	Price (inc VAT & Delivery) (£)
Electric Stove	1.5	1.5	418	271.5 x 277.5 x 275	200	50	1,530
Electric Heater	1.5	1.5	418	No Oven	No Oven	40	1,225

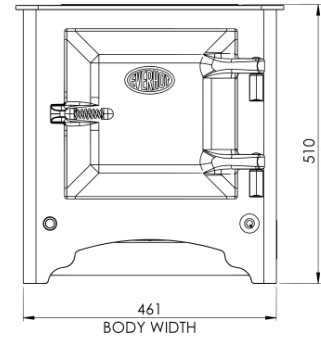
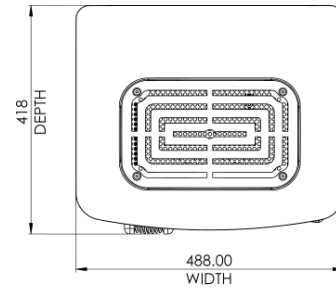

EVERHOT GRILL £1,995.00 inc. VAT

ACCESSORIES

- Weather Shield £175
- Chapa plate £125
- Parilla Grill £125
- Weight 60kg

DIMENSIONS

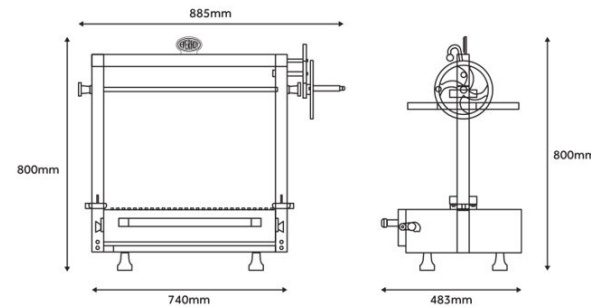

Cooking area: 575mm W x 378mm D



PRODUCT RANGE

Specifications and Prices

Valid from 01/04/2024

Everhot Ltd, Coaley Mill, Coaley, Dursley, Gloucestershire, GL11 5DS, UK
01453 890018 sales@everhot.co.uk







www.everhot.co.uk

Range Specifications Issue 18 – April 2024

Everhot Models

Key

(all dimensions in mm)

	Oven (with grill) - max. 250°C	W395 x H290 x D490
	Oven – max. 200°C	W395 x H290 x D470
	Oven – max. 180°C	W395 x H290 x D470
	Oven – max. 120°C	W395 x H290 x D470
	Oven – approx. 120°C **	110+ only: W395 x H290 x D440
	Plate warming oven – approx. 60°C***	W290 x H290 x D540
	Plate warming oven – approx. 50°C***	100i: W290 x H290 x D540 150i: W390 x H140 x D400
	Control panel	

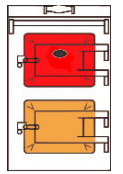
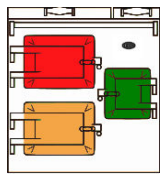
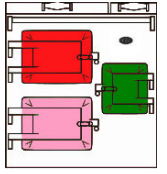
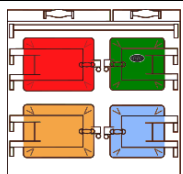
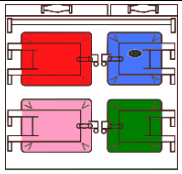
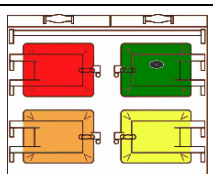
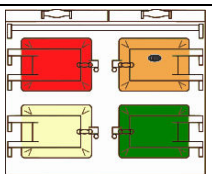
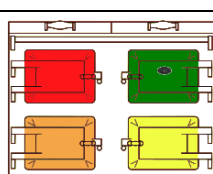
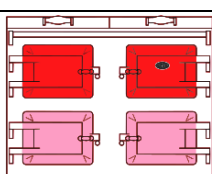
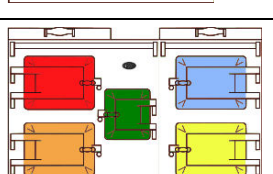
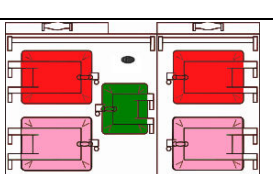
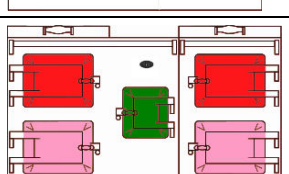
Model	Number of ovens	Number of 13A power supplies	Hot plate (controllable) W235 x D355 mm Δ 110+ W344 x D 344 mm	Simmer plate (controllable) W165x D355 mm Δ 110+ W344 x D 344 mm	Simmer plate (not controllable) W165 x D355 mm	Induction Hob (zones)	Power consumption using ECO overnight (kWh per week)****	Typical heat output (W)	Width (mm)	Depth (mm)	Height (mm) (to hob surface)	Height (mm) (lid up)	Approximate weight (kg)	Price (£)* Including VAT at 20%
EVH 60 	2	1	1	1	-	-	75	600	598	600	900	1530	250	7,275.00
EVH 90 	2	1	1	1	1	-	90	700	890	600	900	1530	300	9,115.00
EVH 90 	2	2	1	1	-	2	75	600	890	600	900	1530	300	9,770.00
EVH 100 	2 + warming	1	1	1	1	-	90	700	995	600	900	1530	350	10,780.00
EVH 100 	2 + warming	2	1	1	-	2	75	600	995	600	900	1530	350	11,095.00
EVH 110 	3	1	1 ^Δ	1 ^Δ	-	-	90	700	1090	600	900	1530	400	12,290.00
EVH 110 	3	2	1	-	1	2	90	700	1090	600	900	1530	400	12,500.00
EVH 120 	3	2	1	-	1	3	90	700	1198	600	900	1530	400	12,750.00
EVH 120 	4	2	2	2	-	-	140	1200	1198	600	900	1530	500	13,550.00
EVH 150 	3 + warming	2	1	-	1	3	90	700	1490	600	900	1530	450	13,695.00
EVH 150 	4	2	2	2	-	-	140	1200	1490	600	900	1530	550	14,400.00
EVH 160 	4	3	2	2	-	2	140	1200	1598	600	900	1530	600	16,500.00

* The delivery and installation price will vary depending on location.
 ** The 110+ bottom oven temperature is non-adjustable, when on it will be approximately 120°C.
 *** Warming ovens do not have heating elements and take their heat from adjacent ovens.
 **** Running costs based on using Eco overnight (2100-0600) and a 3 hour oven delay

Optional Chrome Pack: £200 including VAT for 60 and 90 models, £250 including VAT for all larger models